

METTLER TOLEDO

Weight/price scales bCom

NETWORK

User manual



METTLER TOLEDO

INTRODUCTION

Your new bCom unit is among the finest precision digital computing scales available. It is simple to use and requires minimum maintenance. These scales come from a proud tradition that has made METTLER TOLEDO the worldwide symbol of the highest quality in precision weighing equipment.

Please read these instructions carefully. You will find operating the unit is very simple. In the unlikely event you should experience difficulties, contact your authorized METTLER TOLEDO SERVICE OFFICE listed in the yellow pages of your telephone directory.

Properly used and maintained, your new scale will provide years of accurate weighing which will protect your profits and your customers. Please handle your scale as you would any fine electronic equipment.

FCC Notice

This device complies with Part 15 of the FCC Rules and the Radio Interference Requirements of the Canadian Department of Communications. Operation is subject to the following conditions: (1) this device may not cause harmful interference, and (2) this device must accept any interference received, including interference that may cause undesired operation.

This equipment has been tested and found to comply with the limits for a Class A digital device, pursuant to Part 15 of FCC Rules. These limits are designed to provide reasonable protection against harmful interference when the equipment is operated in a commercial environment. This equipment generates, uses, and can radiate radio frequency energy and, if not installed and used in accordance with the instruction manual, may cause harmful interference to radio communications. Operation of this equipment in a residential area is likely to cause harmful interference in which case the user will be required to correct the interference at his own expense.

©Mettler-Toledo, Inc. 2000



No part of this manual may be reproduced or transmitted in any form or by any means, electronic or mechanical, including photocopying and recording, for any purpose without the express written permission of Mettler-Toledo, Inc.

U.S. Government Restricted Rights: This documentation is furnished with Restricted Rights.

**METTLER TOLEDO RESERVES THE RIGHT TO MAKE REFINEMENTS OR CHANGES
WITHOUT NOTICE.**

PRECAUTIONS

READ this manual BEFORE operating or servicing this equipment.

	 WARNING
	<p>ONLY PERMIT QUALIFIED PERSONNEL TO SERVICE THIS EQUIPMENT. EXERCISE CARE WHEN MAKING CHECKS, TESTS AND ADJUSTMENTS THAT MUST BE MADE WITH POWER ON. FAILING TO OBSERVE THESE PRECAUTIONS CAN RESULT IN BODILY HARM.</p>

FOLLOW these instructions carefully.

	 WARNING
	<p>FOR CONTINUED PROTECTION AGAINST SHOCK HAZARD CONNECT TO PROPERLY GROUNDED OUTLET ONLY. DO NOT REMOVE THE GROUND PRONG.</p>

SAVE this manual for future reference.

	 WARNING
	<p>DISCONNECT ALL POWER TO THIS UNIT BEFORE INSTALLING, SERVICING, CLEANING, OR REMOVING THE FUSE. FAILURE TO DO SO COULD RESULT IN BODILY HARM AND/OR PROPERTY DAMAGE.</p>

DO NOT allow untrained personnel to operate, clean, inspect, maintain, service, or tamper with this equipment.

 CAUTION
<p>BEFORE CONNECTING/DISCONNECTING ANY INTERNAL ELECTRONIC COMPONENTS OR INTERCONNECTING WIRING BETWEEN ELECTRONIC EQUIPMENT ALWAYS REMOVE POWER AND WAIT AT LEAST THIRTY (30) SECONDS BEFORE ANY CONNECTIONS OR DISCONNECTIONS ARE MADE. FAILURE TO OBSERVE THESE PRECAUTIONS COULD RESULT IN DAMAGE TO OR DESTRUCTION OF THE EQUIPMENT OR BODILY HARM.</p>

ALWAYS DISCONNECT this equipment from the power source before cleaning or performing maintenance.

CALL METTLER TOLEDO for parts, information, and service.

 CAUTION
<p>OBSERVE PRECAUTIONS FOR HANDLING ELECTROSTATIC SENSITIVE DEVICES.</p>















Contents

Generalities	5
Keyboard	5
Programming membrane.....	6
Preparatory actions	7
Presentation of the "DATA ENTRY" menu.....	7
PLU definition	9
Price change	10
Define presets.....	11
Tare entry.....	12
Create Barcode	13
Vendor key configuration	14
Discount key configuration.....	15
Instruction for special offers.....	17
Choose the print paper (ticket or label).....	18
Sales mode.....	19
Mode switching	19
Register (with printing on customer ticket)	20
Void	21
Register (with printing on label)	21
Tare.....	22
Prepacking.....	23
Select the prepacking mode	23
Procedure	23
Large sales mode	24
Maintenance	25
Replacing the thermal paper roll	25
Cleaning the print head.....	25
Appendix A: Network configuration.....	26
Appendix B: Error message	27
Appendix C: Fonts table	30

Generalities

Keyboard

Meaning of the function keys

<p> Free entry of a price per piece</p> <p>[PRINT] (PRINT,V2,V3,V4) Vendor, clerk</p> <p> Numeric keypad</p> <p> Clear;</p> <p> Customer total, Confirm</p> <p> Manual entry of a price per piece to add</p> <p> Manual entry of a price per piece to subtract</p> <p> Multiplication</p> <p>[FIX] Fixed unit price / fixed tare</p> <p> Change back</p> <p> Void</p>	<p> Continue</p> <p> Go back</p> <p>[TARE] Tare</p> <p> Zero</p> <p> Code and switching</p> <p> Mode and switching</p> <p> Paper feed</p>
---	---

Special functions keys

1 to 70	preset keys
V2,V3,V4	vender keys V2-V4
[-%]	increase/decrease key (Discount key)

Note: The left 70 keys are preset keys which can store 140 PLUs.













Remark:

*V2, V3 and V4 key can be configured as preset keys or vender keys, but one function is available at one time.

*[-%] key can be configured as preset key or increase/decrease key, but only one function is available at one time.





Programming mode

Meaning of the 'programming" keyboard keys

	Go to beginning of text
	Go to end of text
	move the cursor one position left in the text edit mode
	move the cursor one position right in the text edit mode
	Go to next sub-menu
	Return to previous sub-menu
	Get upper case characters in text edit mode Or select a key's 2nd function
	Backspace (delete the character left of the cursor)
	Delete the character on the cursor
	Insert a character on the cursor
	Center the text in text edit mode
	Carriage returns (next line)
	Selection of a menu

Preparatory actions

Presentation of the "DATA ENTRY" menu

    Call the "DATA ENTRY" menu

DATA ENTRY

- 01 price change
- 02 create plu
- 03 copy plu
- 06 edit extra text
- 07 list plu
- 08 delete plu
- 09 Define presets
- 10 list presets
- 11 standard preset
- 12 delete preset
- 14 create group
- 15 list group
- 16 delete group
- 26 create sp. offer
- 27 sp. offer backw.
- 28 delete sp. offer
- 29 list sp. offer

30	tare
32	create barcode
35	ticket header
36	ticket bottom
38	running message
39	create operator
40	list operator
41	delete operator
42	shop name
43	advertisement
44	date text
45	date / time
46	discount
47	pack date offset
48	message as power on scale
49	Store logo number

Select desired menu with   or enter preset code and activate with  key.

PLU definition

CODE 1 * Call the "DATA ENTRY" menu

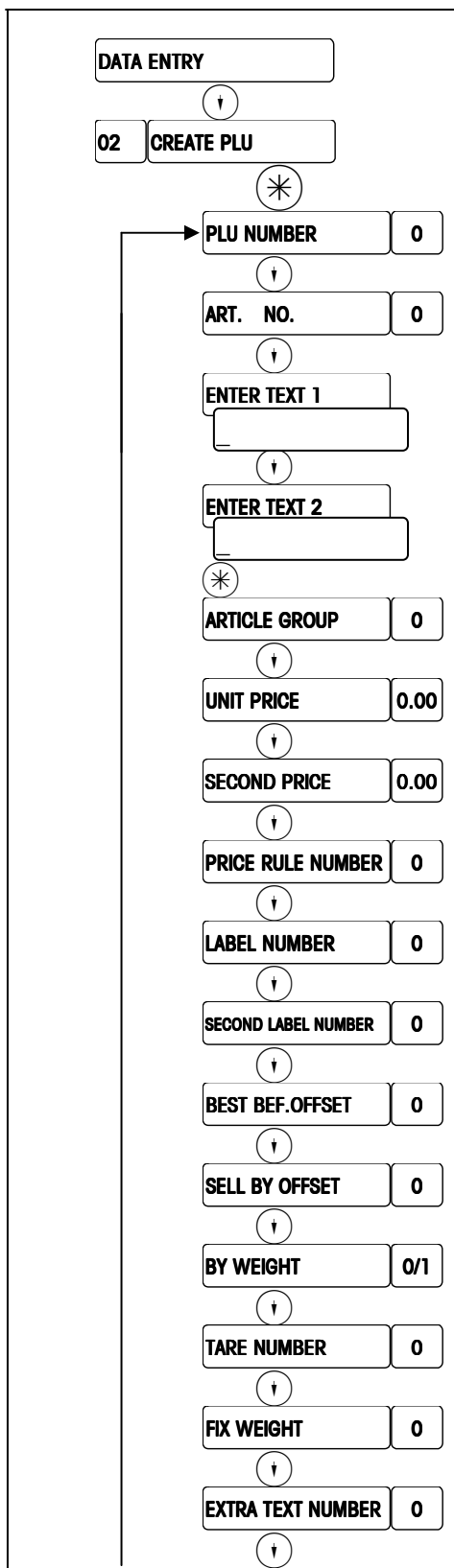

Press the \uparrow key twice or enter the preset code 02.

Enter the PLU number.(1~999999)

Enter the article number (up to 13 figures).

Enter the commodity text 1(up to 28 characters)

Enter the commodity text 2(up to 150 characters)
(Should first set the quantity of characters in CODE 5)

Enter the article group number.(1~99)

Enter the unit price.(0~9999.99)

Enter the second unit price.(0~9999.99)

Select the price using first price or second price.

Input the label number (0-108, 101~108 are fixed label formats)

Input second label number

Input the best before offset.(0-999 days)

Input the sell by offset.(0-999 days)

Is it an article per piece or a weighed article ?
0 = weighed article, 1 = article per piece

Input preset tare number.(1-99)

Input the FIX WEIGHT for article per piece

Input the Extra Text number.

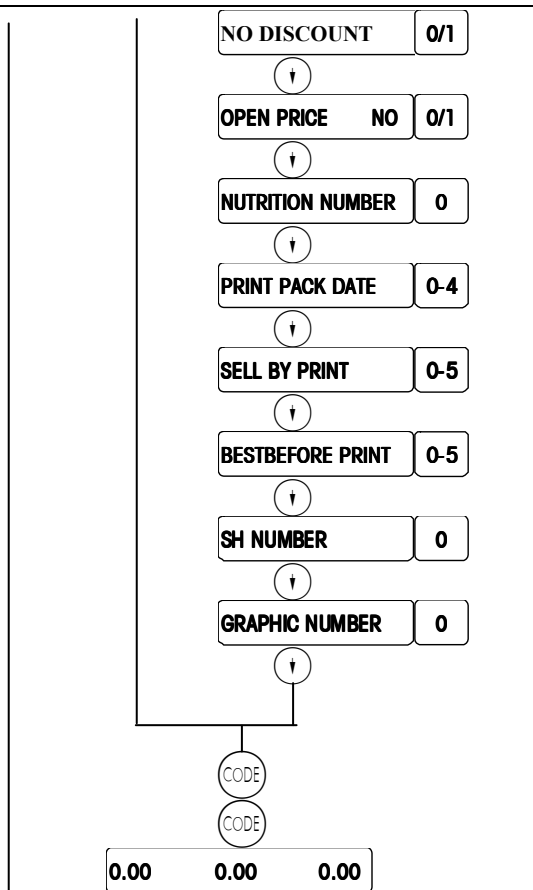

0=no increase/decrease 1=enable increase/decrease

0=price can't be changed

1=price can be changed by # key

Input the nutrition number.

Select if print pack date, 0=Not print, 1=YYMMDD, 2=MMDD, 3=MMDDYY, 4=DDMMYY,

Select if print sell by date, 0=Not print, 1=YYMMDD, 2=MMDD, 3=MMDDYY, 4=DDMMYY, 5=DAYS

Select if print best before date, 0=Not print, 1=YYMMDD, 2=MMDD, 3=MMDDYY, 4=DDMMYY, 5=DAYS

Safe handling number.

Graphic number

Press \downarrow to enter or change other PLU.

Press the CODE key twice to return to the weighing mode.

Note: Each option can be selected or hided in menu [CODE] 6-16

Price change

CODE 1 * Call the "DATA ENTRY" menu

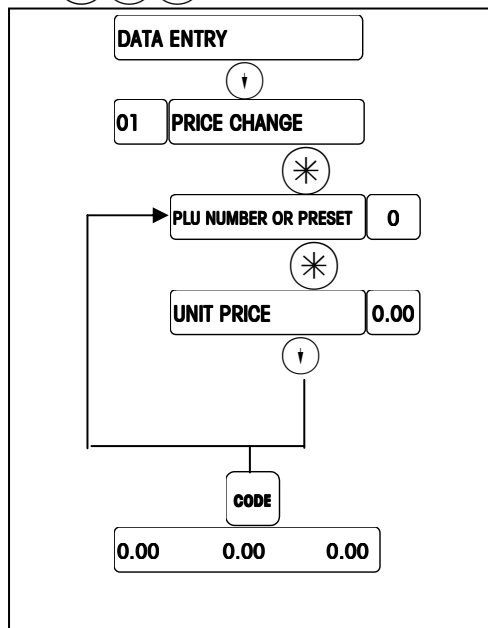

Press the \downarrow key twice or enter the preset code 01.

Enter price change

Enter PLU number.(up to 6 digits)

Enter the unit price.

Press \downarrow for other price changes.



Press CODE to return to weighing mode.

Define presets

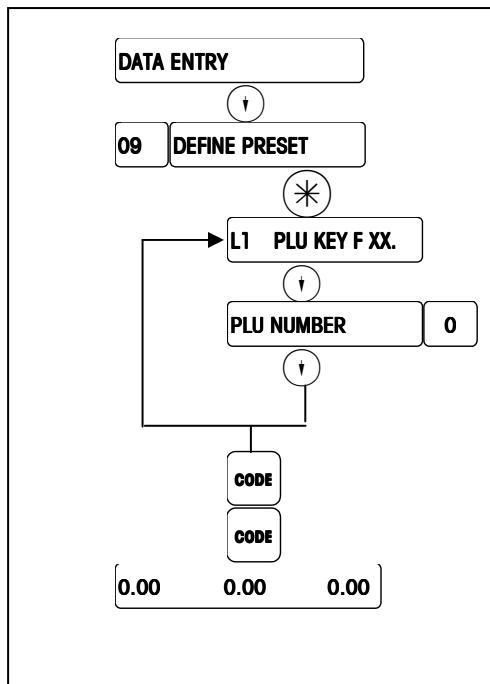
 Call the menu "DATA ENTRY"



Enter preset code 09.





*Press the desired PLU preset key
 (Shift L1 and L2 by the key )
 Enter PLU number.(up to 6 digits)
 Press  to enter or modify another PLU preset.

Press  2 times to return to weighing mode.

Remark:

*The Type bCom can store 140 preset keys which are divided into two levels L1 and L2.
 L1 can store P1~P70 and L2 can store P71~P140.
 Shift L1 and L2 by the key .
 (You can double click for calling PLU of level 2)

Tare entry

    Call the "DATA ENTRY" menu

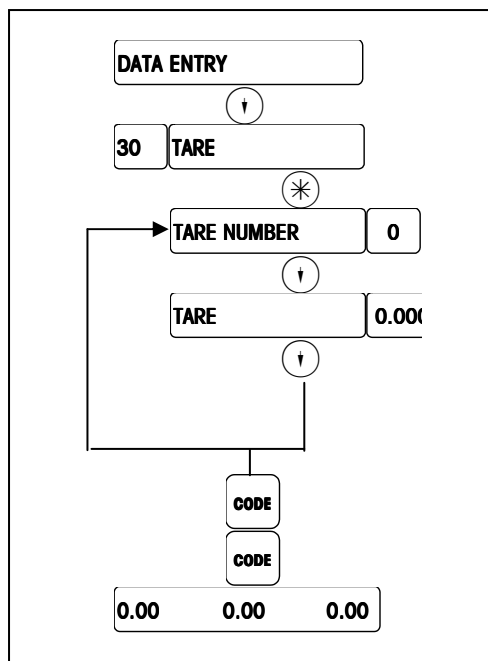

Enter the preset code 30

Enter the tare number (1-99).

Enter the tare weight in grams *)

Press  to affect the next tare memory.

Press the  key twice to return to the weighing mode.

*) Respect the increment (1 g, 2 g or 5 g, depending on the weighing range)

Create Barcode

☞ CODE 1 * Call the "DATA ENTRY" menu

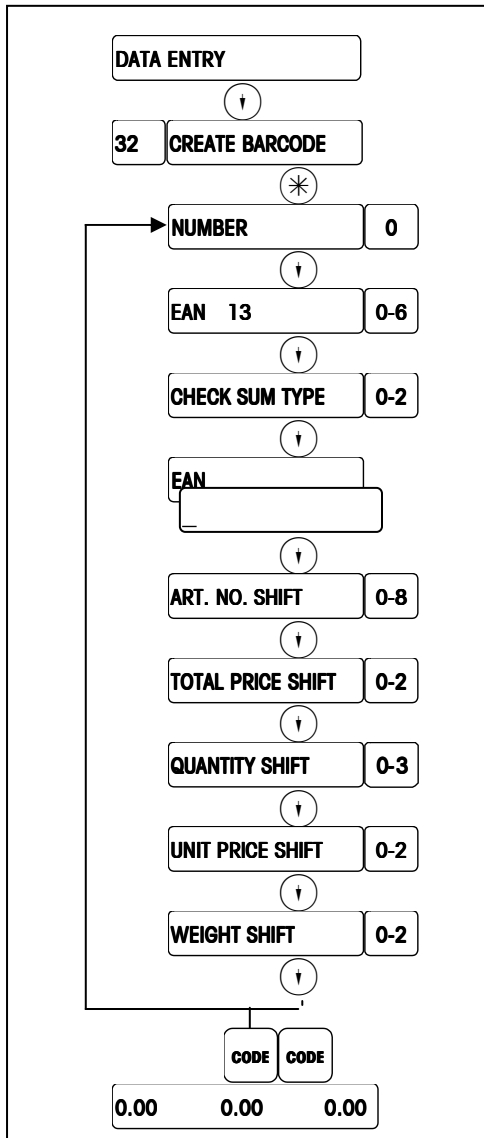

Legend of Barcode Identifications

- A = Item number 4 - 12 figures
- B = Total Price 4/5/6 figures
- C = Check digit 1 figure
- D = Date 2/4/6 figures
- N = Ticket number 4 figures
- P = PLU code 4/5/6 figures
- Q = Weight/Quantity 4/5 figures
- W = Group number 2 figures
- 0-9 Figures 1 - 12 figures

Enter the preset code 32

Enter the EAN number (1-8).

Select barcode type

0=EAN8,1=EAN 13,2=ITF 25 Narrow,3=ITF 25 Wide,4=EAN 128,5=EAN 13+5,6=UPC-A

Select CHECK SUM type, 0=Normal, 1=Reverse, 2=No check sum

Enter the EAN CODE such as 22AAAAAABBBBBB etc.

Select shift digit for the Article number in barcode

Select shift digit for the total price in barcode

Select shift digit for the quantity in barcode

Select shift digit for the unit price in barcode

Select shift digit for the weight in barcode

Press \downarrow to affect the next EAN code memory.

Press the CODE key twice to return to the weighing mode.

Examples:

- 0AAAAAAAAA (UPC, Ten digit Item Number)
- 2AAAAACBBBB (UPC, 5-D Item/Price Check Digit/4-D Price)
- 2AAAAOBBBB (UPC, 5-D Item/Zero Fixed/4-D Price)
- 2AAAAABBBBB (UPC, 5-D Item/No Price Check/5-D Price)
- 2AAAAACQQQQ (UPC, 5-D Item/Wgt Check Digit/4-D Wgt)
- 2AAAAAQQQQ (UPC, 6-D Item/No Price Check/4-D Wgt)
- 2AAAAQQQQQ (UPC, 5-D Item/No Price Check/5-D Wgt)
- 21AAAAABBBBB(EAN,5-D Item/5-D Price)
- 21AAAABBBBB(EAN, 4-D Item/6-D Price)
- 21AAAAACBBBB(EAN,5-D Item/Price Check Digit/4-D Price)
- 21AAAACBBBB(EAN,4-D Item/Price Check Digit/5-D Price)
- 21AAAAQQQQQ(EAN,5-D Item/5-D Wgt)
- 21AAAACQQQQQ(EAN,4-D Item/Wgt Check Digit/5-D Wgt)

***NOTE:** The default label format uses the NO.1 barcode format. The free label format you can select the barcode number in label editing software.

Vendor key configuration

- Vendor name edit

☞ **CODE** 1 * Call the "DATA ENTRY" menu

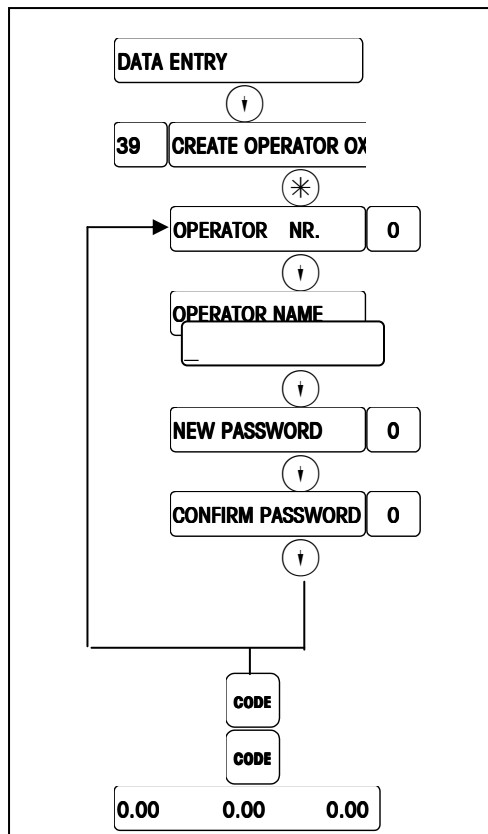

Enter preset code 39.

Enter the number of the desired vendor.

Enter the name of the vendor.

If necessary input the password of the vendor

Confirm the password

Press **↓** to enter or modify another vendor's number.

Press the **CODE** key twice to return to the weighing mode.

- Vendor preset key permission

☞ **CODE** 3 * Call the "KEYBOARD CONFIGURATION" menu

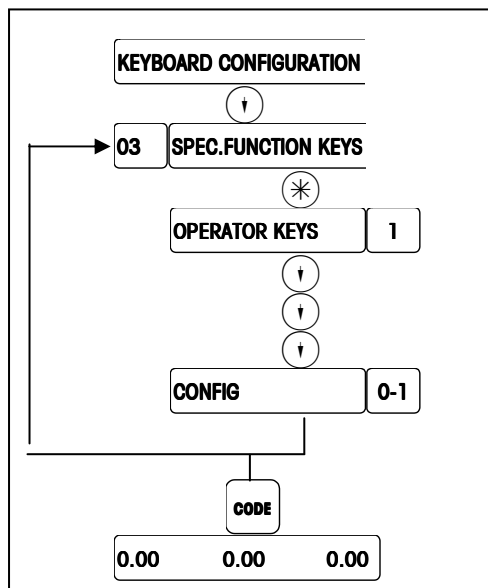

Enter preset code 03.

Enter number of operator keys.(1~4)

0=Don't storage the configuration.

1=Storage the configuration.

Press the **CODE** key to return to the weighing mode.

• Log in and log out an operator

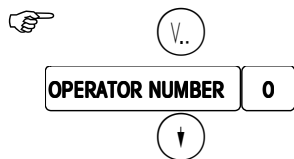

Press vendor key about 10 sec until display 'operator number'
Then input operator number.
Then confirm with down arrow key.

Discount key configuration

• Discount rate edit

Hand icon pointing to CODE key, then 1 key, then * key. Call the "DATA ENTRY" menu

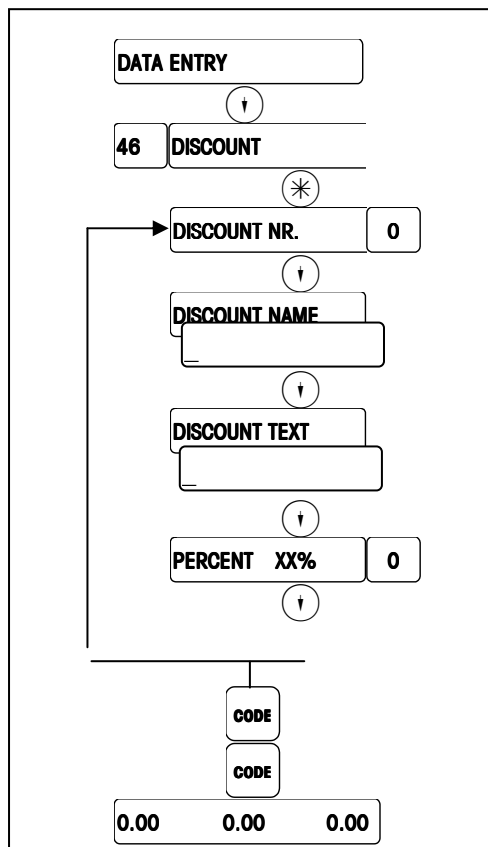

Enter preset code 46.

Enter increase/decrease number(1~9).

Enter increase/decrease name.

Enter increase/decrease text.

Enter increase/decrease rate.

Press the CODE key twice to return to the weighing mode.

• **Discount permission**

☞ **CODE** 6 * Call the "SPECIAL FUNCTION" menu

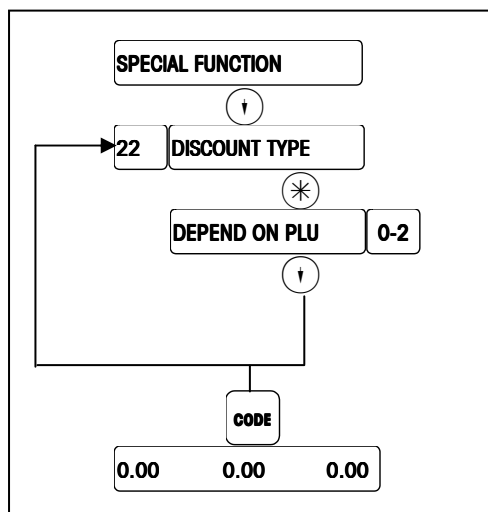

Enter preset code 22.

0=depend on PLU
 1=all PLU enable, 2=all PLU disable

Press the **CODE** key to return to the weighing mode.

• **Log in increase/decrease key**

☞ **CODE** 3 * Call the "KEYBOARD CONFIGURATION" menu

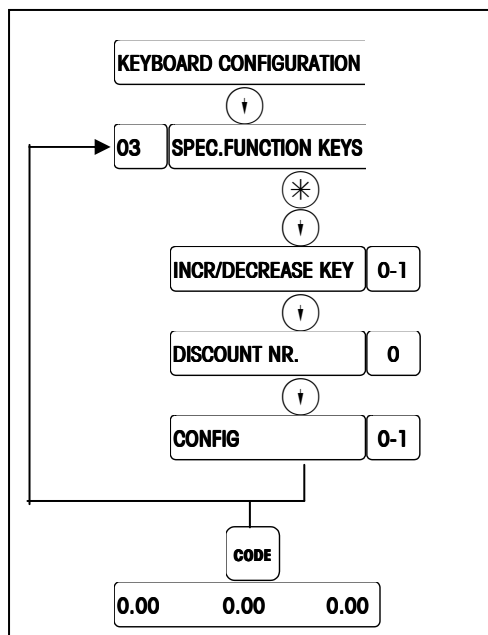

Enter preset code 03.

0=Disable increase/refund
 1=Enable increase/refund

Enter increase/refund number
 0=Don't storage the configuration
 1=storage the configuration

Press the **CODE** key to return to the weighing mode.

Instruction for special offers

- Define a special offer

Call the "DATA ENTRY" menu

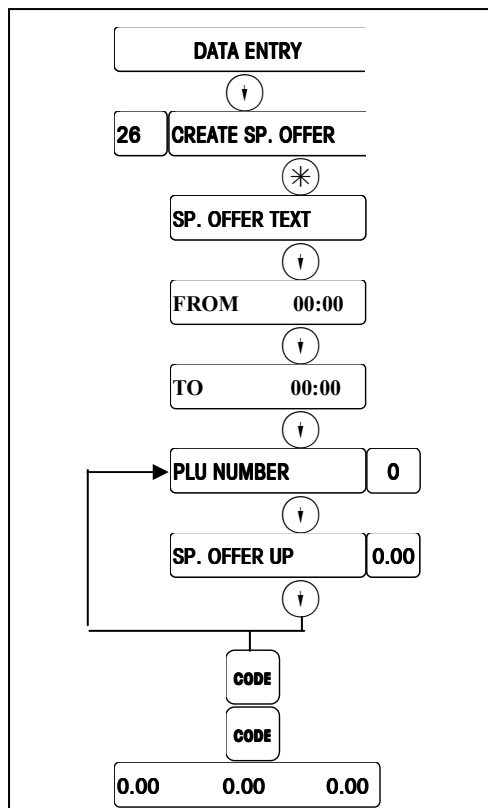

Enter preset code 26.

Enter the special offer text.

Enter the time the special offer starts.

Enter the time the special offer ends.

Enter the PLU number.

Enter the special offer of the article.

Press the key to create special offer price of another PLU.

Press the key twice to return to the weighing mode.

- Cancel a special offer

Call the "DATA ENTRY" menu

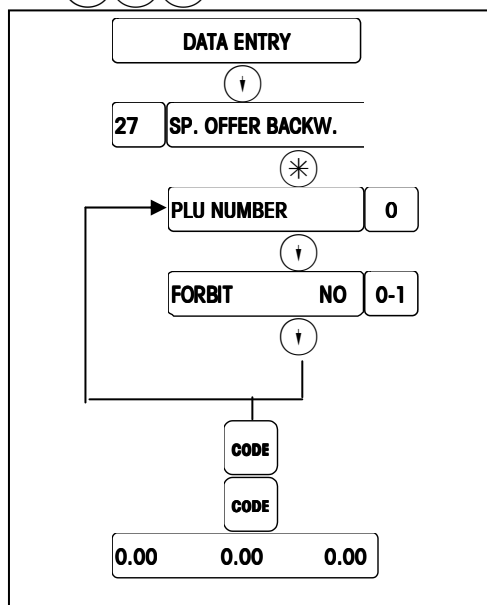

Enter preset code 27.

Enter the PLU number.





0=No prohibition

1=Prohibit SP. OFFER for this PLU

Press the key to prohibit special offer price of another PLU.

Press the key twice to return to the weighing mode.

Choose the print paper (ticket or label)

    Call the "OPERATOR CONFIG" menu

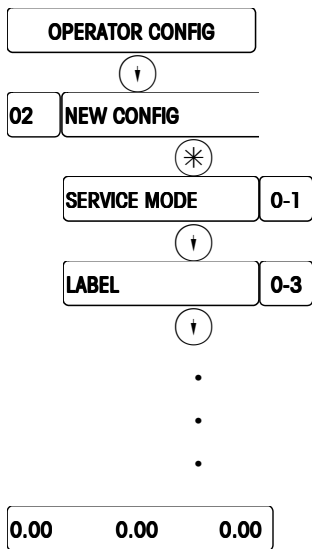

Enter preset code 02.

Select the status of service mode or prepack mode when open the scale

0=service mode; 1=prepack mode

0=cust. ticket; 1=label; 2=label+total label, 3=total label



Press the  key until return to the weighing mode.

Sales mode

Mode switching

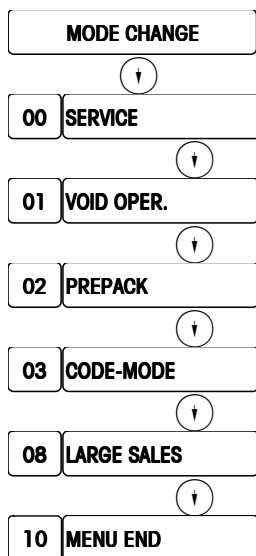
 Call the menu "Mode switching"



With   select the desired sub-menu, or enter the preset code.

Select/return to service mode.



Select/return to void operation mode.

Select/return to prepack mode.

Select/return to code mode.

Select/return to large sales mode.

Press  to continue or  to return to weighing mode.

With   or the preset code, select the corresponding menu item, then activate it with the  key.

Service mode

-For all weighing functions, registering, data entry and sales reporting

Code mode

-Enter the code functions

Void oper. mode

-VOID OPERATION AFTER CHECK OUT means the ticket or label has been printout, and these transactions will be deleted from the statistics data.

Prepack mode

-For packing fieldwork of the supermarket. In this application, only print label, the small variety but large quantity print-work.

Large sales mode

-When the article is too big to weigh, operator can enter this mode by inputting the article weight and count price.

Register (with printing on customer ticket)

1. Weighed PLU/ PLU per piece / overwriting of a defined price per piece

- Put the article on the scale.
- Press a direct PLU preset key or enter the PLU code.
(Overwriting of a defined price per piece :
The defined price per piece can eventually be overwritten by the current article, by pressing (#)).
or press (#) key first to enter a weighed price. For an article per piece, first press (+) or (-) to entry the temporary price.
- Register the transaction with your personal (V..) key.
- Register the next article.
- Conclude the sale and print off the customer ticket by pressing the (*) key, followed by your personal (V..) key.

2. Subtotal

Displaying the subtotals of all the vendors



Displaying the subtotal of vendor x



By repeatedly pressing the (v) key, check the subtotal of every vendor.

3. Calculating the change

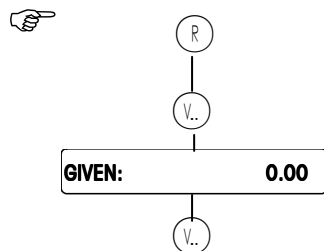

To use the "Calculating the change function", you only have to conclude the sale by the following sequence of keystrokes, the key [R] replaces the key (*).
Enter the amount received by the client.

The cash register opens automatically.

Void

a) The last operation



b) one of the previous operations



Remarks: With you have an overview of the different transactions printed on the ticket.

c) total operations



Register (with printing on label)

Weighted PLU/ PLU per piece / overwriting of a defined price per piece

- Put the article on the scale.
- Press a direct PLU preset key or enter the PLU code.
(Overwriting of a defined price per piece :
The defined price per piece can eventually be overwritten by the current article, by pressing).
Or press key first to enter a weighed price. For an article per piece, first press or to entry the temporary price.
- With your personal key , start printing the label.

Tare**a) Compensation of a weighed tare (tare an empty recipient)**

- Place the empty recipient.
- Press the [TARE] key.
- Put the full recipient and register the transaction.
- The tare weight is cleared from the moment the transaction is registered and the scale is cleared.

b) Tare manually

As the weight is zero, you can press the Tare key and input the tare value manually and confirm with Tare key.

c) PLU specific tare weight

The tare is linked with PLU, recall the PLU to call it.

d) Fixed tare compensation

- Put tare weight on the scale.
- Press the [TARE] key.
- Press the $\text{\textcircled{F}}$ key.

Prepacking

Select the prepacking mode

 Call the menu "Mode switching"

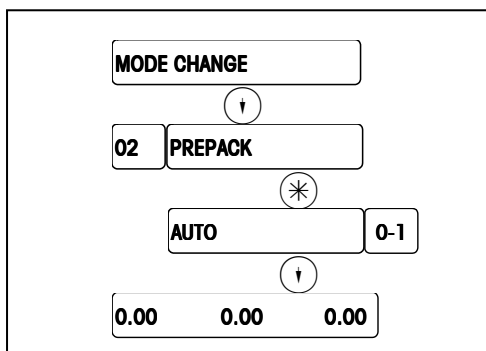

Enter preset code 02.

Select/return to prepack mode

Select the print triggering mode:

0=print after stabilizing; 1=print by pressing the vendor key.

Procedure

- Select the PLU with [Enter] key
- Place the article
- Issue the label automatically, if you select manually in mode you should press vendor key
- Remove the label
- Weight the next article and scale will issue label automatically

Print a batch of prepack labels for the article by Count PLU

This function can be in prepack mode only, it is in effect under auto-print status. And only for the articles by Count PLU.

 ENTER ONE PLU NUMBER

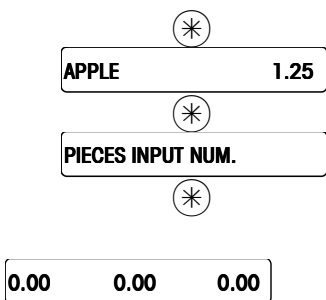

Before you call a plu, you must empty the platter of scale.

Active batch print function

Display the price of the PLU, you can enter number follow X key for more than one.

Enter print quantity(max.999 pcs)

After the previous label is taken away, then print the next label.

NOTE: Press the key  twice can quickly switch prepack mode and service mode.

Large sales mode

 **MODE** Call the menu "Mode switching"

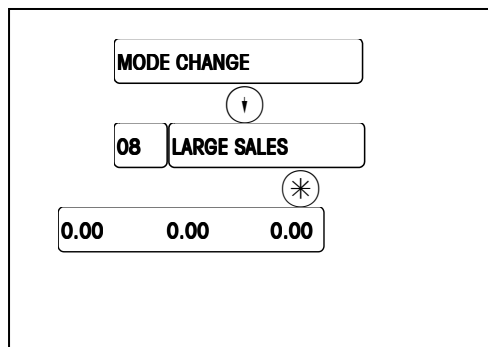

Enter preset code 08.

Enter large sales mode

After entering large sales mode, operator shall first input the called PLU, Then press the key **#**, input large sales weight and register this transaction. If the price is required to input temporarily, operator shall first press the key **#**, and then enter the temporal price, again press the key **#**, input large sales weight and register this transaction at last.

Maintenance

Replacing the thermal paper roll

- Pull out printer on the right side of the scale.
- Remove the empty reel.
- Press down the green lever.
The print head flips out of his housing.
- Insert the new thermal paper roll in accordance with the drawing.
- Pull out the paper until correct tension is reached.
- Push back the print head until it clicks.
- Tear off the paper that sticks out.
- Close the weighing plate.

Cleaning the print head

- Switch off the scale.
- Pull out printer on the right side of the scale.
- Press down the green lever.
The print head flips out of his housing.
- Take off the cap from the cleaning pen.
- Clean the print head with the moist tip of the pen.
- Push back the print head until it clicks.
- Put on the cap of the cleaning pen.
- Pull back the printer, close the door.
- Switch on the scale.



Use only the cleaning pen (with 98% and above alcohol), for cleaning the print head.
Other cleaning materials will destroy the print head.

Appendix A: Network Configuration

Call the menu "Technical service"

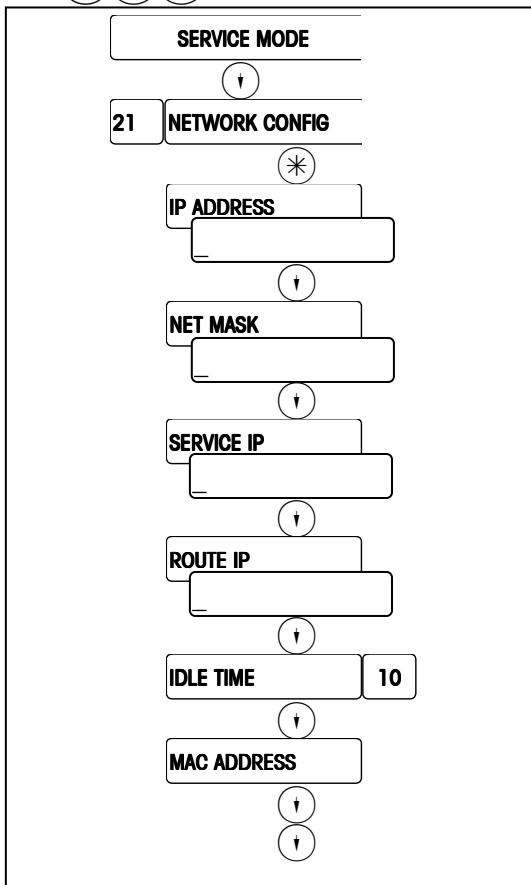

Enter the preset code 21.

Enter network configure

Input IP address

Input NET MASK address

Input SERVER IP address (If necessary)

Input ROUTE IP address (If necessary)

Input IDLE TIME (10 is ok)

Press to exit.

After completing setup, if necessary you can choose the PLU SOURCE. The operation as bellow:

Call the menu "Technical service"

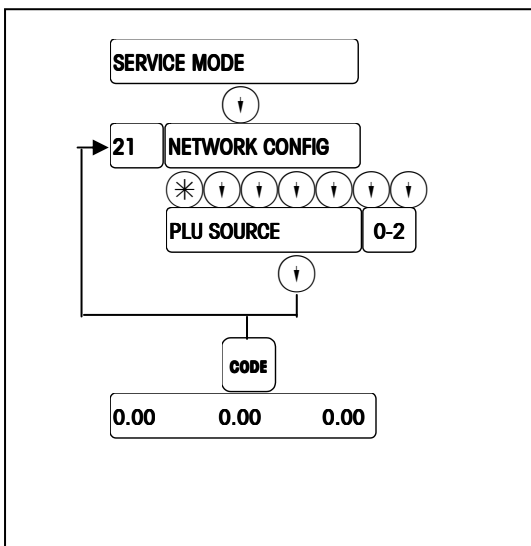

Enter the preset code 21.

0=Get PLU from local scale

1=Get PLU from NETWORK

2=First from network,then from local scale

Press to exit .

Appendix B: Error Message

- **Warning Message**

INPUT TOO BIG---The input is too big.

INPUT TOO SMALL---The input is too small.

TOO MUCH INPUT---The input is out of limit.

WRONG CODENR.---The code number is invalid.

KEY NO FUNCTION---The key has no function.

KEY BLOCKED---The key is disabled. Check the KEYBOARD CONFIGURE.

PLU NOT FOUND---The entered PLU number does not exist.

AG NOT FOUND---The entered Group number does not exist.

OPER.NOT FOUND---The entered Operator number does not exist.

LABEL NOT FOUND---The entered Label Format does not exist.

PLUNR IS OCCUP---You are trying to duplicate a PLU into an exist PLU number.

LABELNR. OCCUP---You are trying to duplicate a label format into an existed label format number.

DISCOUNT IMPOSS---This PLU does not allow to be discounted. Check the PLU Discount configuration, or this PLU is in special offer.

NO FURTHER REG.---No further transaction has been recorded.

NO STABLE WEIGHT---The weight is not stable.

AG NOT DELETABLE---This Group contains total data and can not be deleted.

OP NOT DELETABLE---This Operator contains total data and can not be deleted.

MEMORY FULL---Memory is full.

WEIGH AGAIN---You are trying to record one item twice. Remove the item from the platter and put a new item on the platter.

WRONG LABEL---The installed label roll does not match the configured label format.

LABEL MOVED---The stepper motor or the rewind motor is not working properly.

CHANGE PAPERROLL---The label roll is not installed or the label roll is empty.

TAKE LABEL OFF---Take off the current label before printing the next one.

NO FREE OX KEY---All the configured operator keys have been occupied.

PRINT TICKET---Print out the customer ticket before logging out.

OPEN CUST. TICK---You are trying to delete an operator who has total data.

OX NOT LOGGED-IN---The operator has not be assigned to an operator.

PAYMENT TOO LOW---The payment is less than the total amount.

TARE TOO BIG---The entered tare is too big.

PLU TARE ACTIVE---You are forbidden to override the PLU tare.

PUT PLATTER ON ---The weight is too small and out of power up zero range.

ZERO NOT CAPTURE ---The weight is too big and out of power up zero range.

WEIGHT TOO SMALL---The weight is too small to be printed.

ERROR TAKE-SENS---The take label sensor is not working properly.

ERROR POS_SENS---The gap sensor is not working properly.

ERROR INTERFACE---The serial port is not working properly.

- **Error Message**

Listed below are the possible error codes are listed. When an error code appears, the scale should be switched off and on. In many cases the error will disappear.

There are 3 different kinds of error messages:

Error Status 1:

Warning! After the warning the scale can still be used.

Error Status 2:

Press "CODE" key. Change to one of the CODE menu. Back to normal operation mode.

Error Status 3:

Press "CODE" key and enter SERVICE MODE 15, after returning to normal operation mode the scale will perform RESET.

Error Message	Reason	Status	Action
ERROR 300 PRINTER	Printer driver defect	2	Replace Main Logic PCB
ERROR 301 PRINTER	Printer driver defect	2	1 Reflash the software 2 Replace Main Logic PCB
ERROR 307 PRINTER	Printhead defect	2	1 Replace printhead 2 Replace printhead harness 3 Replace Main Logic PCB
ERROR 308 PRINTER	Printer driver defect	1	Replace Main Logic PCB
ERROR 310 PRINTER	Printer driver defect	2	Replace Main Logic PCB
ERROR 101 AP	Real Time Clock defect	1	Replace Main Logic PCB
ERROR 400 CELL	Load Cell defect	-	1 Replace Main Logic PCB 2 Replace Load Cell
ERROR 401 CELL	Load Cell defect	-	1 Recalibrate 2 Replace Main Logic PCB 3 Replace Load Cell
ERROR 200 DATABASE	Data bank error	3	Work config.
ERROR 201 XX DATABASE	XX Data error	2	1 Work config. 2 Delete Data XX
ERROR 202 XX DATABASE	XX Data error	2	1 Work config. 2 Delete Data XX
ERROR 203 YY DATABASE	YY Data error	2	1 Work config. 2 Configure YY
ERROR 205 DATABASE	Data bank error	3	Work config.

Meaning of XX

01 Operator	07 Group data
02 Ticket data	13 Label data
03 Time total data	15 Date text data
04 Text data	21 PLU label data
05 Barcode data	23 Store address
06 Tare data	24 PLU data

Meaning of YY

01 Operator Configure	04 Password Configure
03 Keyboard Configure	

Appendix C: Fonts Table

Font No.	Font Type	Height in mm	Characters per line
1	AaBbCcDdEeFfGgHhIiJjKkLlMmNnOoPp	1.9	36
2	AaBbCcDdEeFfGgHhIiJjKkLlMmNnOoPp	2.4	36
3	AaBbCcDdEeFfGgHhIiJjKkLlMmNnOoPp>	2.9	36
4	AaBbCcDdEeFfGgHhIiJjKkLlMmNnOoPp	3.7	36
5	AaBbCcDdEeFfGgHhIiJjKkLlMmNnOoPp	4.8	36
6	AaBbCcDdEeFfGgHhIiJjKkLl	3.2	27
7	AaBbCcDdEeFfGgHhIiJjKkLl	6.4	27
8	AaBbCcDdEeFfGgHh	2.4	18
9	AaBbCcDdEeFfGgHh	2.9	18
10	AaBbCcDdEeFfGgHh	3.7	18
11	AaBbCcDdEeFfGgHh	4.8	18
12	AaBbCcDdEeFfGgHh	4.8	18
13	AaBbCcDdEeFfGgHh	9.6	18
14	AaBbCcDdEeFf	3.2	13
15	AaBbCcDdEeFf	6.4	13
16	AaBbCcDdEe	2.9	11
17	AaBbCcDdEe	3.7	11
18	AaBbCcDdEe	4.8	11
19	AaBbCcDd	4.8	9
20	AaBbCcDd	9.6	9

In conformance with the European Directive 2002/96/ EC on Waste Electrical and Electronic Equipment (WEEE) this device may not be disposed of in domestic waste.

This also applies to countries outside the EU, per their specific requirements.

Please dispose of this product in accordance with local regulations at the collecting point specified for electrical and electronic equipment.



If you have any questions, please contact the responsible authority or the distributor from which you purchased this device.

Should this device be passed on to other parties (for private or professional use), the content of this regulation must also be related.

Thank you for your contribution to environmental protection.

METTLER TOLEDO

Scales & Systems

1900 Polaris Parkway
Columbus, Ohio 43240

P/N 72222803

(3/09).02

METTLER TOLEDO®

Is a registered trademark of Mettler-Toledo, Inc.

©2000 Mettler-Toledo, Inc.



* 7 2 2 2 2 8 0 3 *